

Industry
TRANSILVAN

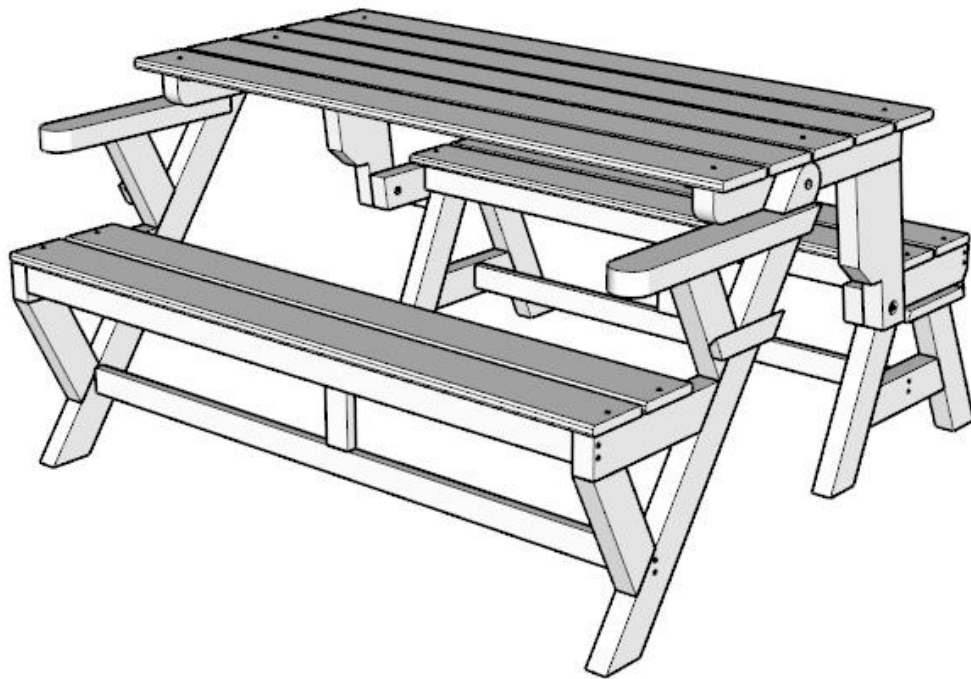

Montana 4-6

INSTRUCTIUNI GENERALE DE FOLOSIRE A PRODUSELOR DE MOBILIER

Pentru a va bucura de investitia dvs. si pentru a o proteja cat mai multi ani, urmati instructiunile de mai jos:

1) Nu lasati lichidele sa interactioneze cu mobilierul.

Orice pata de lichid trebuie stearsa imediat cu o carpa moale si uscata, in directia fibrelor lemnului. Pe suprafetele din piatra, lichidele trebuie sterse imediat cu un prosop de hartie si apoi uscate pentru a evita formarea petelor.

2) Nu lasati mobilierul expus la lumina soarelui, surse de caldura sau umezeala sau sub ferestre deschise.

Expunerea excesiva la soare poate cauza pierderea luciului si degradarea mobilierului. Schimbarile extreme de temperatura si umezeala pot cauza crapaturi si desprinderi ale finisajelor.

3) Nu asezati obiecte din cauciuc sau plastic pe suprafata mobilierului.

Substantele chimice din componenta cauciucului sau plasticului pot intra in reactie cu finisajele mobilierului daca sunt lasate in contact cu acesta mai mult timp. Pentru a evita aparitia urmelor de la aceste obiecte, asezati-le pe o bucata de material textil.

4) Nu asezati obiecte fierbinti pe suprafata mobilierului.

Intotdeauna folositi un platou inainte de a aseza recipientul fierbinte pe mobilier.

5) Curatati numai cu o carpa curata si moale din material textil.





Curatarea in mod frecvent previne formarea zonelor cu abraziune, care in timp pot deteriora finisajele mobilei in timp. Micile zgarieturi sau semne pot fi acoperite cu produse destinate acestui scop. Aceste produse pot fi gasite in magazinele de specialitate sau de bricolaj.

Capacitatea max: 120 kg / pers

Asamblarea produsului este ajutat de instructiunile de mai jos. Citiți cu atenție întregul manual înainte de a începe să montați și/sau să utilizați acest produs. Urmați îndeaproape instrucțiunile din manual și păstrați-l pentru consultare ulterioară.

IMPORTANT!

Este important ca șuruburile de orice tip, cu ajutorul cărora au fost montate produsele, să fie strânse din nou la 2 săptămâni după montare și, apoi, o dată la 3 luni, pentru a se asigura stabilitatea de-a lungul duratei de viață a produsului.

<p>A x4</p>  <p>M6x80</p>	<p>B x4</p>  <p>M6</p>	<p>C x4</p>  <p>M6</p>	<p>D x20</p>  <p>Ø4x70</p>	<p>E x14</p>  <p>Ø4x50</p>
--	---	---	--	---

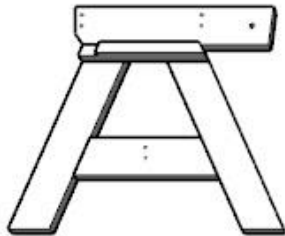

No.1 x1

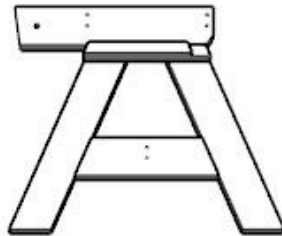

No.2 x1

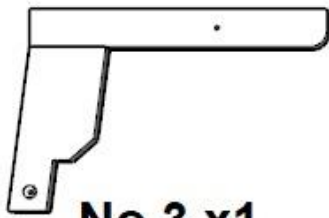

No.3 x1

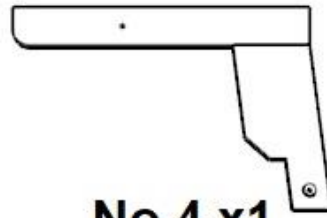

No.4 x1

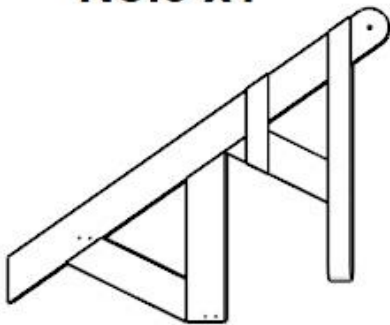

No.5 x1

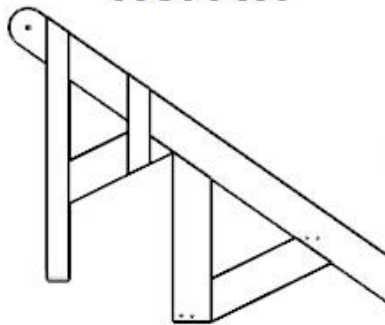

No.6 x1

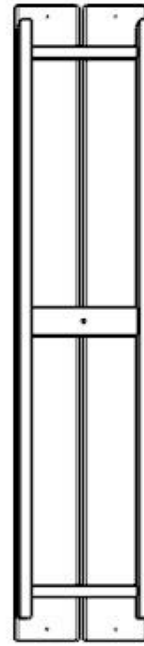

No.8 x1

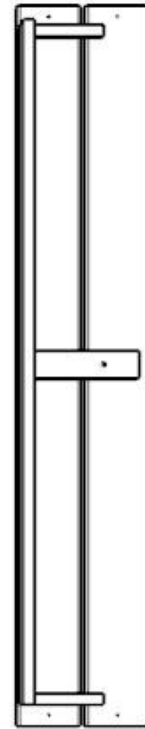

No.9 x1

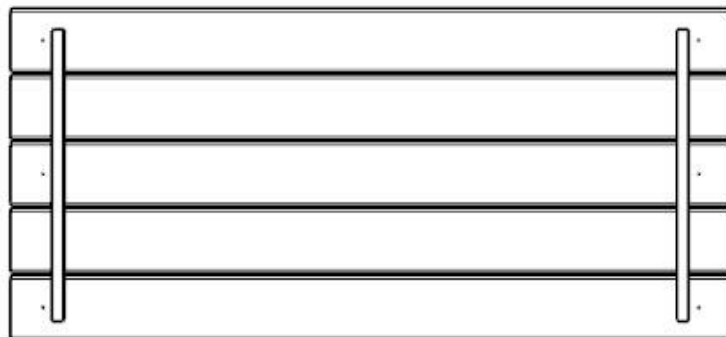

No.7 x1

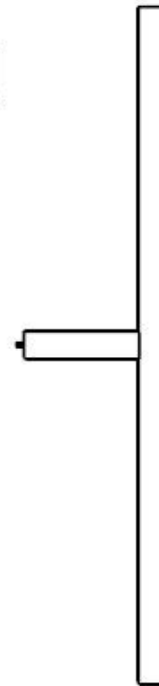

No.10 x1

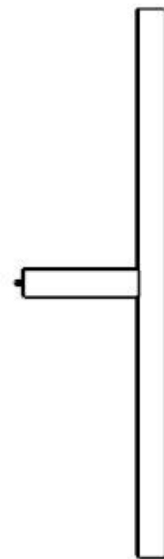

No.11 x1

